

DOREL ASIA SRL

CONVERTIBLE SLEIGH CRIB

Model No: WM1633-O

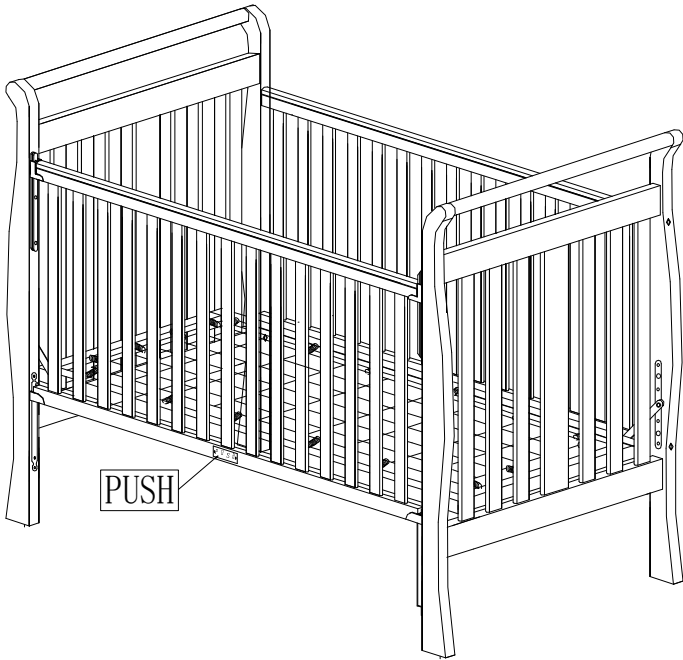

NOTE:
This instruction booklet
contains **IMPORTANT** safety
information. Please read and
keep for future reference.

Lot number:
(TAKEN FROM CARTON)

Date of purchase:

____ / ____ / ____

DO NOT RETURN PRODUCT TO THE STORE.
If a part is missing or damaged, contact our customer service
department. We will replace the part **FREE** of charge.



Tel # : 1-800-295-1980
E-Mail: das@dorel.com
Fax #: 514-353-7819

CUSTOMER SERVICE

If you are missing parts or have any questions about this product, contact our customer service representative first!



CALL 1-800-295-1980

You can also order parts by writing to the address listed below. Please include the product model number, color and a detailed description of the part.

**Customer Service Department No. 413
12345 Albert-Hudon Boulevard, Suite 100
Montreal, Quebec
Canada H1G 3L1**

E-MAIL: das@dorel.com



WARNING

- * Failure to follow these warnings and assembly instructions could result in serious injury or death.
- * Read all instructions before assembling crib. **KEEP INSTRUCTIONS FOR FUTURE USE.**
- * Before each usage or assembly, inspect crib for damaged hardware, loose joints, missing parts or sharp edges, **DO NOT** use crib if any parts are missing or broken. Ask your dealer or write to our customer service representative (address & phone number shown above) for replacement parts and instructional literature if needed. **DO NOT** substitute parts.
- * Infants can suffocate on soft bedding. Never add a pillow, comforter or padding.
- * When child is able to climb out or reaches the height of 35 inches (90 cm), the crib shall no longer be used.
- * To reduce the risk of SIDS, pediatricians recommend healthy infants be placed on their backs to sleep, unless otherwise advised by your physician.
- * **DO NOT** place crib near window where cords from blinds or drapes may strangle a child.
- * Strings can cause strangulation! **DO NOT** place crib with a string around a child's neck, such as hood strings or pacifier cords. **DO NOT** suspend strings over a crib or attach strings to toys.
- * To help prevent strangulation tighten all fasteners. A child can trap parts of the body or clothing on loose fasteners.
- * If refinishing, use a non-toxic finish specified for children's products.
- * When child is able to pull to standing position, set mattress to lowest position and remove bumper pads, large toys and other objects that could serve as steps for climbing out.
- * Never use plastic shipping bags or other plastic film as mattress covers because they can cause suffocation.
- * **DO NOT** use a water mattress with this crib.
- * Replace teething rail if damaged or loose (if teething rail is provided for this model).
- * **CAUTION: ANY MATTRESS USED IN THIS CRIB MUST BE AT LEAST 27-1/4 INCHES BY 51-5/8 INCHES (69CM BY 131CM) WITH A MINIMUM THICKNESS OF 4 INCHES (10CM) BUT NOT EXCEEDING 6 INCHES (15CM).**

- * Infants can suffocate in gaps between crib sides and a mattress that is too small.

WARNING ENTRAPMENT / STRANGULATION HAZARD:

- * Infants have died in toddler beds from entrapment and strangulation
- * **NEVER** use bed with children under 15 months.
- * **NEVER** place bed near windows where cords from blinds or drapes may strangle a child.
- * The **TODDLER BED** or **DAY BED** is not intended for children under 15 months of age or over 50 pounds (22.7kg).
- * If guardrails are used as the mattress containment means, guardrail(s) provided must be used to avoid the formation of a gap between the mattress and the bed that could cause an entrapment (when product is used as a **TODDLER BED** or **DAY BED**).
- * **DO NOT** place **DAY BED** or **TODDLER BED** near windows where cords from blinds or drapes may strangle a child.
- * **DO NOT** place items with a string, cord, or ribbon around a child's neck, such as hood strings or pacifier cords.
- * **DO NOT** suspend strings over a **TODDLER BED** or **DAY BED** for any reason.

NOTES

- * Ensure all parts and components are present before beginning assembly.
- * Assemble on soft, smooth surface to prevent damage to product finish.
- * Phillips head screw driver is not included.
- * DO NOT use power tools.
- * CAUTION: Adult assembly required.
- * Assembly will require two people.



WARNING: Should this product become damaged, and/or components are broken or missing, DO NOT USE.

CARE AND CLEANING

Dust regularly with a soft, lint-free cloth to prevent soil build-up. A damp cloth may be used occasionally to clean surface. Dry immediately. Do not use any abrasives that may damage finish. Excessive exposure to sunlight and extreme changes in temperature and moisture can damage wood furniture.

If the crib is to be stored, store in cool dry place and carefully package all original hardware to protect from loss.

MAINTENANCE





Check bolts/screws periodically and tighten them if necessary.

DOREL ASIA LIMITED WARRANTY

Dorel Asia warrants its product to be free from defects in material and workmanship and agrees to remedy any such defect. This warranty covers 1 year from the date of original purchase. This warranty is valid only upon presentation of proof of purchase. This is solely limited to the repair or replacement of defective furniture components and no assembly labor is included. This warranty does not apply to any product which has been improperly assembled, subjected to misuse or abuse or which has been altered or repaired in any way. This warranty gives you specific legal rights and you may also have other rights which vary from State to State.

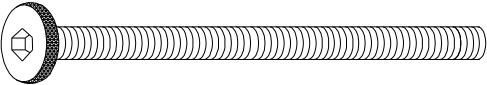
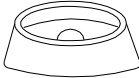
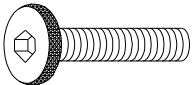
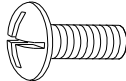
3-IN-1 CONVERTIBLE SLEIGH CRIB WM1633-O

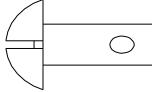
HARDWARE LIST

1	 $\varnothing 1/4" \times 2-3/4"$	4	
HEX SOCKET HEAD BOLT 6 PCS		RUBBER STOPPER 2 PCS	
2	 $\varnothing 6 \text{ mm} \times 3/4"$	5	 $\varnothing 3/16" \times 3/8"$
HEX SOCKET HEAD BOLT 16 PCS		BOLT 2 PCS	
3		6	
ALLEN KEY 1 PC		GATE PIN 2 PCS	
		7	
		BARREL NUT 4 PCS	
		8	
		BARREL NUT 2 PCS	

3-IN-1 CONVERTIBLE SLEIGH CRIB WM1633-O

PARTS LIST

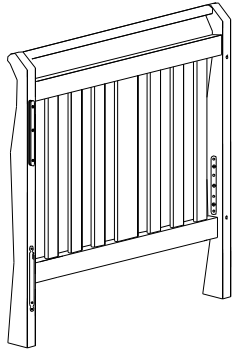
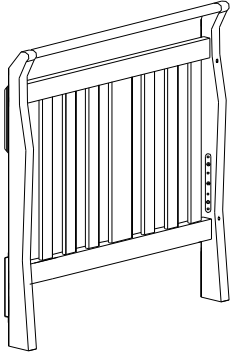
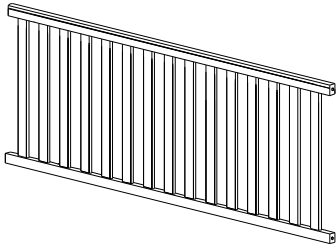
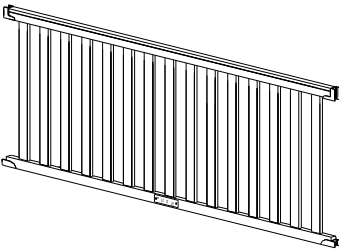
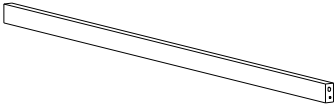
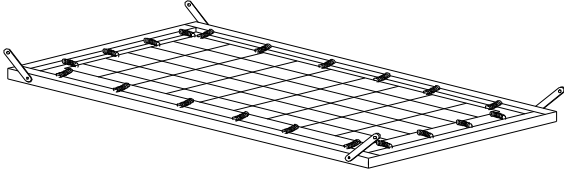
G-L		G-R	
LEFT SIDE FRAME 1PC		RIGHT SIDE FRAME 1PC	
H		I	
STATIONARY SIDE 1PC		DROP SIDE 1PC	
J		K	
GUARD RAIL 1PC		MATTRESS SUPPORT 1PC	

3-IN-1 CONVERTIBLE SLEIGH CRIB WM1633-O

NOTE: PLEASE MAKE SURE THE TEETHING RAILS ON THE DROP SIDE (I) AND STATIONARY SIDE (H) ARE FACING UP.

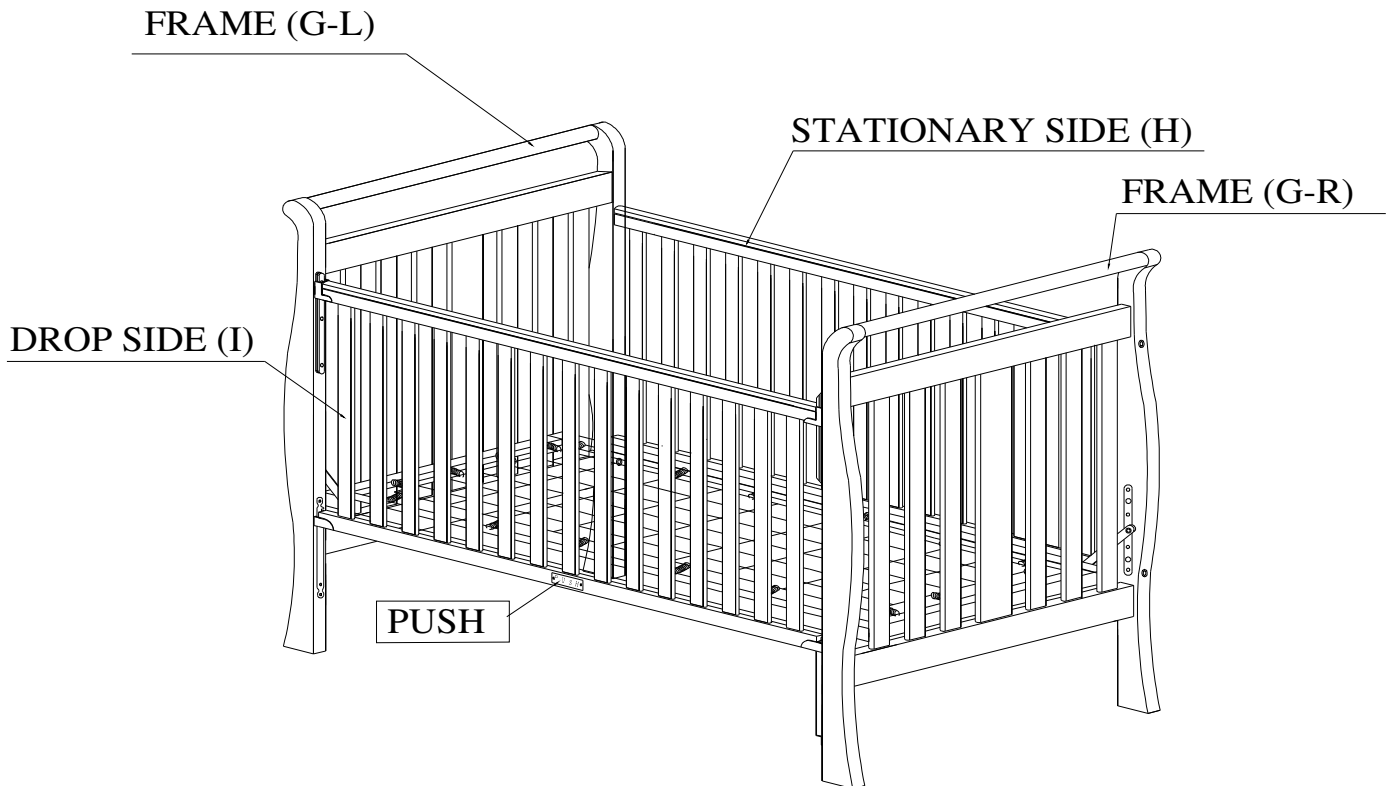

CRIB ASSEMBLY INSTRUCTION

NOTE: When inserting bolts, turn clockwise until tighten. Then loosen 1/2"-3/4" of a turn. After crib is completely assembled, return to each bolt and tighten. Use wax or soap on all bolts to facilitate assembly.

3-IN-1 CONVERTIBLE SLEIGH CRIB WM1633-O

STEP 1

Attach left and right side frames (G-L) & (G-R) to stationary side (H) with hex socket head bolts (1) and barrel nut (7) . Use Allen key (3) to tighten hex socket head bolts.

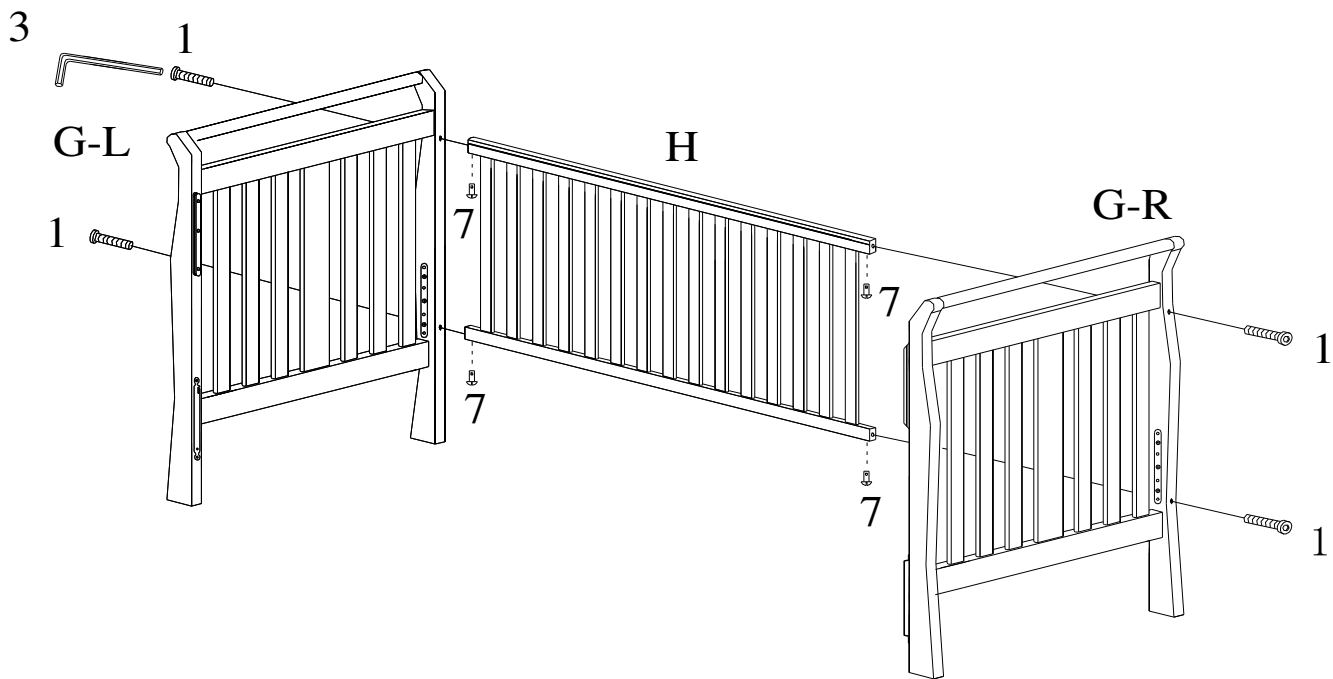
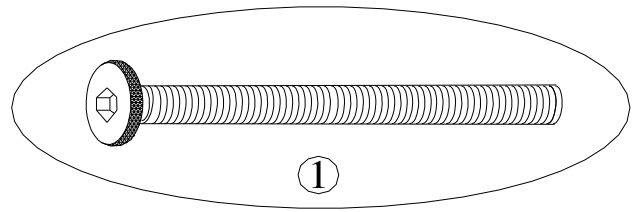

3-IN-1 CONVERTIBLE SLEIGH CRIB WM1633-O

STEP 2

Attach mattress support (K) to the side frames (G-L) & (G-R) with 4 hex socket head bolts (2). Use Allen key (3) to tighten hex socket head bolts.

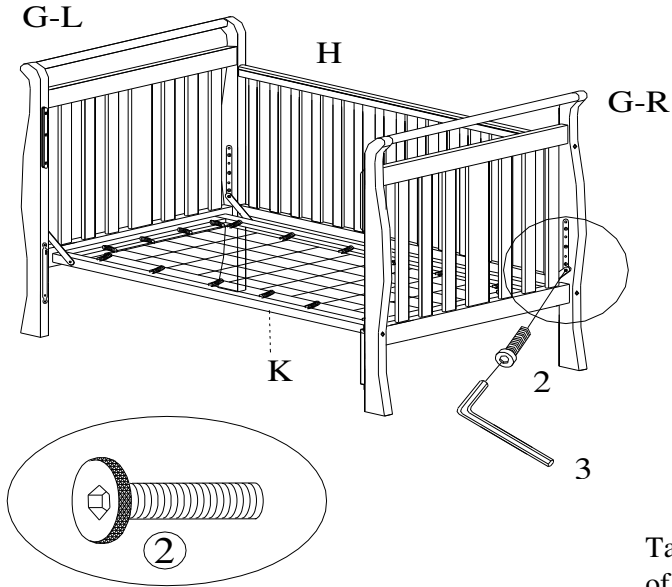

Raised edge should face down - this photo show mattress support is upside down

INCORRECT



Tabs on corners of mattress support should point up

INCORRECT



Tab to point up

Flat surface of mattress support to face up - mattress must sit on flat surface

CORRECT

Note: Ensure the flat side of the mattress support (K) is facing up.

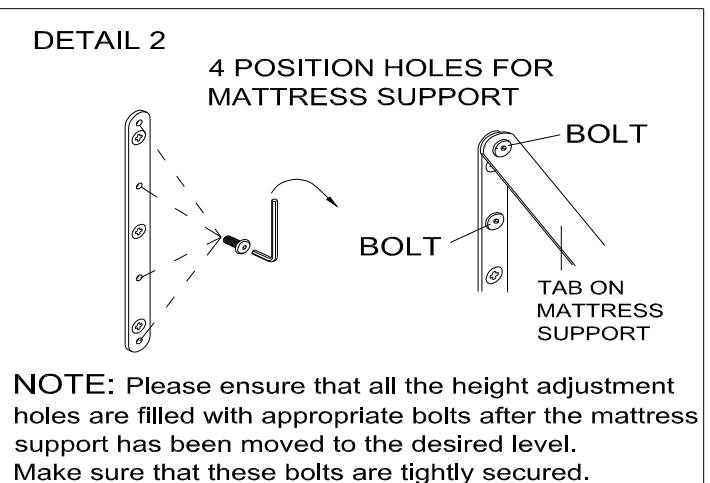
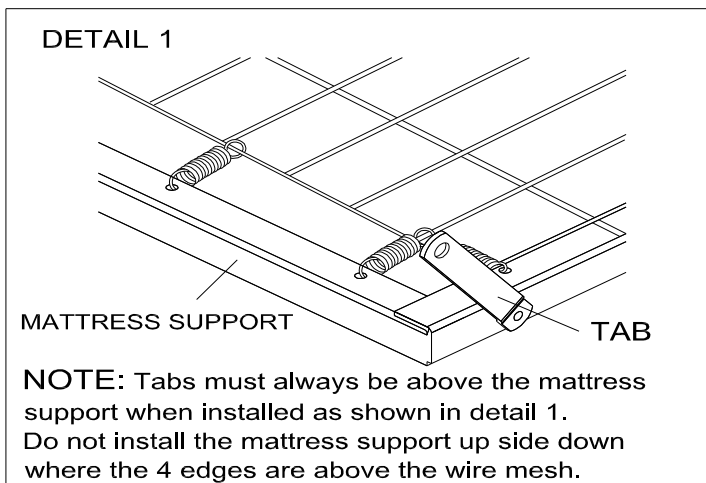

3-IN-1 CONVERTIBLE SLEIGH CRIB WM1633-O

STEP 3

Align and slide drop side (I) from the bottom onto the drop side upper and lower tracks on the left and right front legs. Make sure the release latch on the lower guides (I) is to the outside of the lower drop side tracks (pull towards you). Raise drop side (I) until it is locked into place.

Caution: DO NOT force the drop side as you may break the locks, guides, or tracks. Attach rubber stoppers (4) before operating drop side.

AFTER DROP SIDE (I) IS INSTALLED ON THE TRACK AND IS LATCHED IN THE UP POSITION, INSERT THE BOLT (5) INTO THE RUBBER STOPPERS (4) AND THREAD INTO THE EMPTY HOLES NEAR BOTTOM ON LOWER TRACK ASSEMBLY (FACTORY MOUNTED).

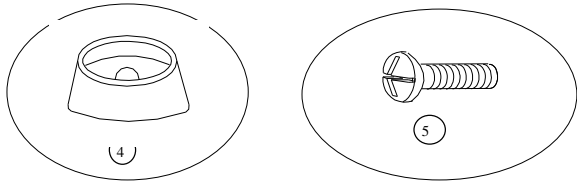
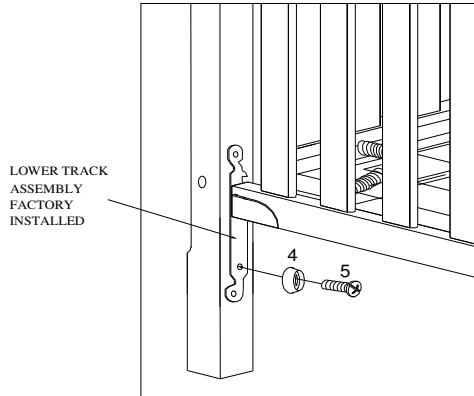
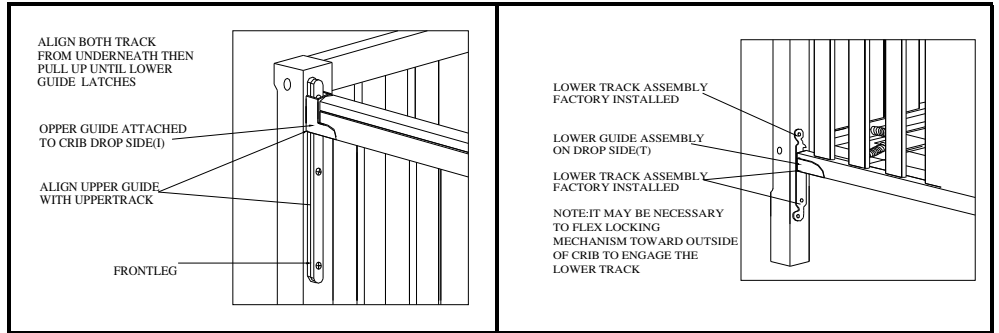

Photo A



Photo B



The release latch on the lower guides must be on the outside of the lower drop side tracks - pull towards you before sliding onto the track.

This rubber bumper must be installed prior to operating drop side - it will prevent drop side from falling to the floor.

NOTE: Photos A & B are to demonstrate how the drop side should be installed. The photos of the wood components of the crib may differ from the crib purchased and are for reference only.

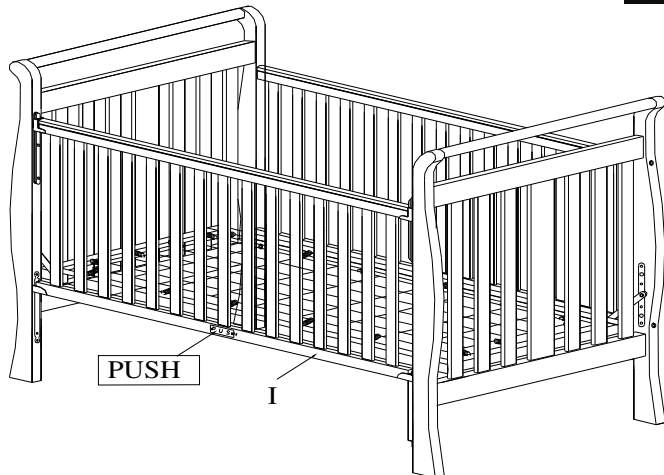

OPERATING INSTRUCTION FOR DROP SIDE.

Stand at the middle of the drop side and hold the top rail with one hand.

Raise the drop side slightly to enable you to release the latch by pushing on the drop side lower rail with your knee. The drop side will now lower. Raise the drop side and it will automatically lock at the upper position.

Always make sure drop side is properly secured.

Note: When assembling the drop side make sure the teething rail is on top.

3-IN-1 CONVERTIBLE SLEIGH CRIB

WM1633-O

TODDLER BED & DAY BED ASSEMBLY INSTRUCTIONS

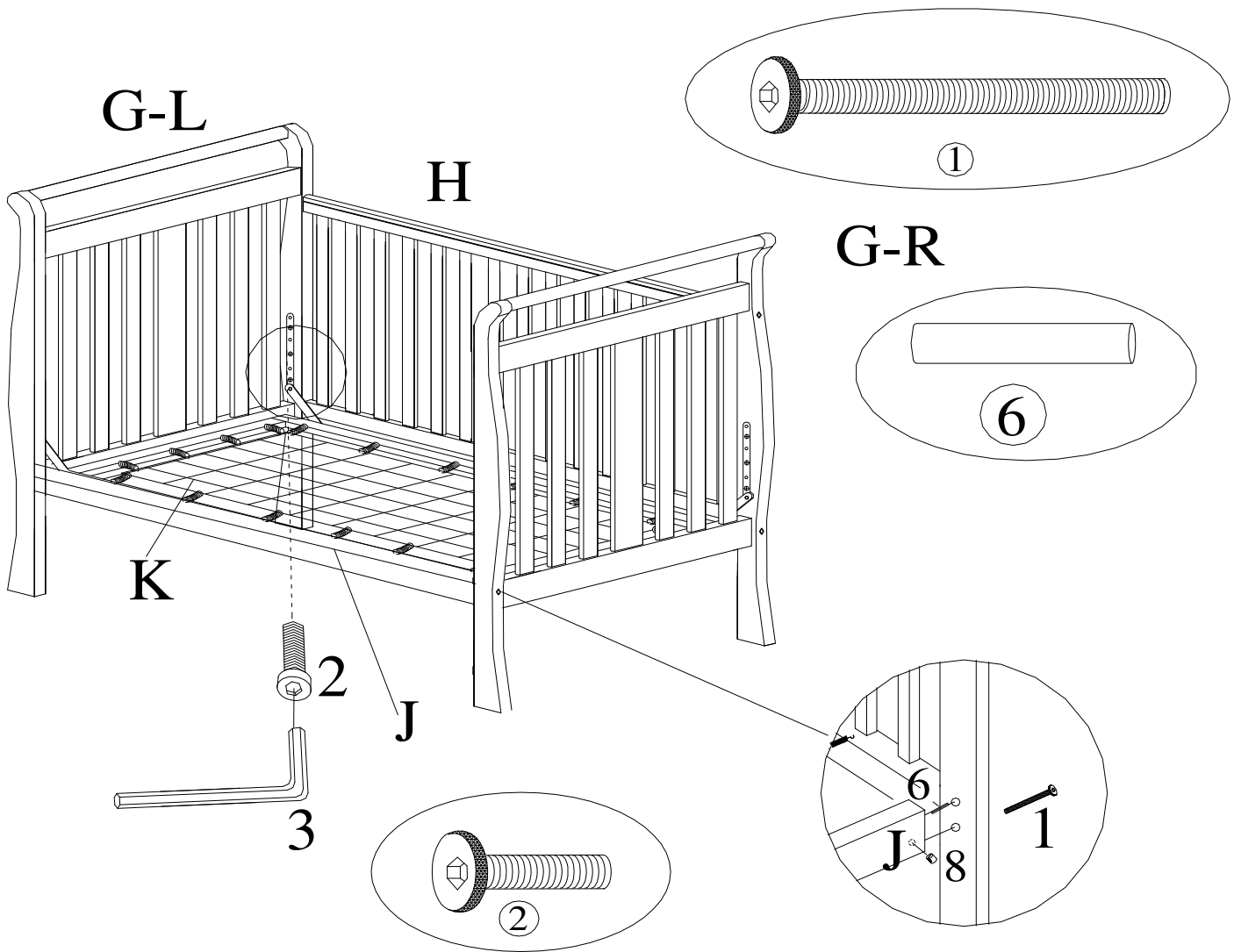

TODDLER BED & DAY BED ASSEMBLY INSTRUCTIONS: STARTING FROM CRIB

STEP 1 Unscrew the rubber stoppers (4) from the lower drop side track on the left (G-L) and right (G-R) front legs.

STEP 2 Detach the drop side (I) from the left and right legs by sliding the upper and lower guides on each end of the drop side down until they are below the upper and lower drop side track the drop side will fall to the floor.

STEP 3 Unscrew and detach the lower and upper drop side tracks from the left and right front legs.

STEP 4 If mattress support (K) is not in the lowest position, unscrew hex socket head bolts (2) from front and back legs and move to the lowest position.

STEP 5 Using the allen key (3) provided, attach guardrail (J) by using hex socket head bolts (1) and barrel nut (8) and gate pins (6) between the left and right legs (See details in DIAGRAM A).

STEP 6 Tighten all screws clockwise.

NOTE: When used as a day bed. The mattress support can be placed at any height desired.

TODDLER BED & DAY BED ASSEMBLY INSTRUCTIONS: STARTING FROM SCRATCH

STEP 1: Follow step 1 to 3 of the crib assembly instruction.

STEP 2: Follow step 2 to 3 for the day bed assembly instruction located above (starting from crib).

3-IN-1 CONVERTIBLE SLEIGH CRIB

WM1633-O



CAUTION This unit is intended for use only with the products and maximum weights indicated. Use with other products or products heavier than the maximum weights indicated may result in instability or causing possible injury ."

* **CAUTION:** Any mattress used in this crib must be at least 27-1/4 inches by 51-5/8 inches (69cm by 131cm) with a minimum thickness of 4 inches (10cm) but not exceeding 6 inches (15cm).

When child is able to climb out or reaches the height of 35 inches (90cm), the crib shall no longer be used.

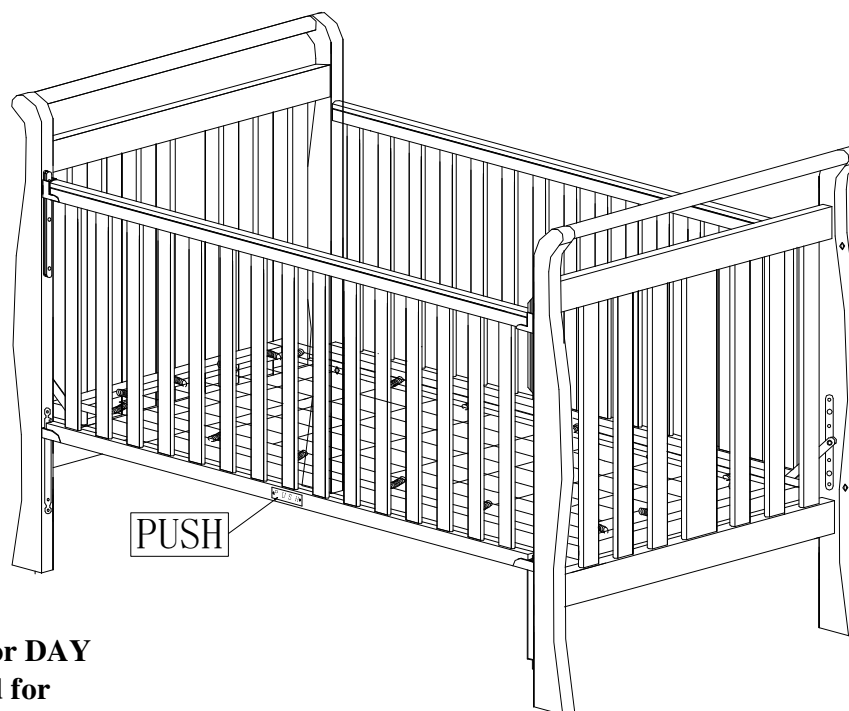

The **TODDLER BED** or **DAY BED** is not intended for children under 15 months of age or over 50 pounds.

DO NOT RETURN PRODUCT TO THE STORE.

If a part is missing or damaged, contact our customer service department. We will replace the part FREE of charge.



Tel #: 1-800-295-1980

E-Mail: das@dorel.com

Fax #: 514-353-7819